

HOUSINGS AND ACCESSORY PRODUCTS

Orifice Disc Installation & Sizing Guide

FLOW-LIMITING ORIFICE DISCS

Standard HydraForce cavity forming tools enable the designer to make convenient use of flow-limiting orifice discs, installed immediately under the cartridge when pilot drill diameters shown on housing details, or smaller, are used.

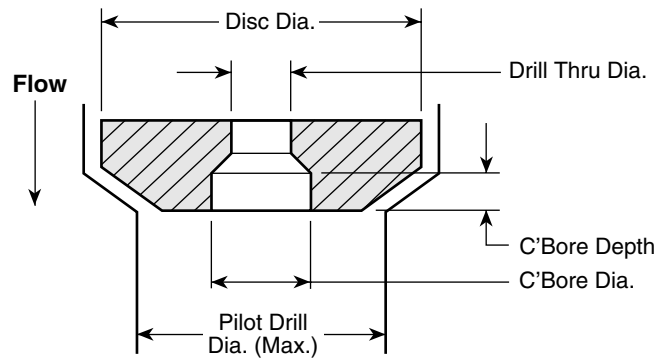

Orifice Discs – 5000 PSID Max.

Orifice Disc Part No.*	Disc Dia. (Max.)	Pilot Drill Dia. (Max.)	Drill-Thru Dia.	Counterbore Dia./ Counterbore Depth
7051_ _ _ for cavities: VC08-2 VC08-4	.500	.437	None	None
			.001 to .062	.125 Dia./ .074 Dp.
			.063 to .109	.2187 Dia./ .050 Dp.
			.110 & Up	None
7057_ _ _ for cavity: VC08-3	.562	.500	None	None
			.001 to .062	.125 Dia./ .074 Dp.
			.063 to .109	.2187 Dia./ .050 Dp.
			.110 & Up	None
7063_ _ _ for cavities: VC10-2 VC10-3 VC10-4	.625	.562	None	None
			.001 to .062	.125 Dia./ .074 Dp.
			.063 to .109	.2187 Dia./ .050 Dp.
			.110 & Up	None
7087_ _ _ for cavities: VC12-2 VC12-3	.872	.718	None	None
			.015	.125 Dia./ .084 Dp.
			.020 to .062	.125 Dia./ .084 Dp.
			.063 to .109	.2197 Dia./ .060 Dp.
7081_ _ _ for cavity: VC12-4)	.810	.781	None	None
			.015	.125 Dia./ .084 Dp.
			.015 to .062	.125 Dia./ .084 Dp.
			.063 to .109	.2197 Dia./ .060 Dp.
			.110 & Up	None

*Last 3 digits determined by drill-thru diameter.

All dimensions shown in inches.

Orifice Disc Installation & Sizing Guide (cont'd)

TYPICAL INSTALLATIONS

See specific product pages to determine if orifice disc can be used with a particular valve.

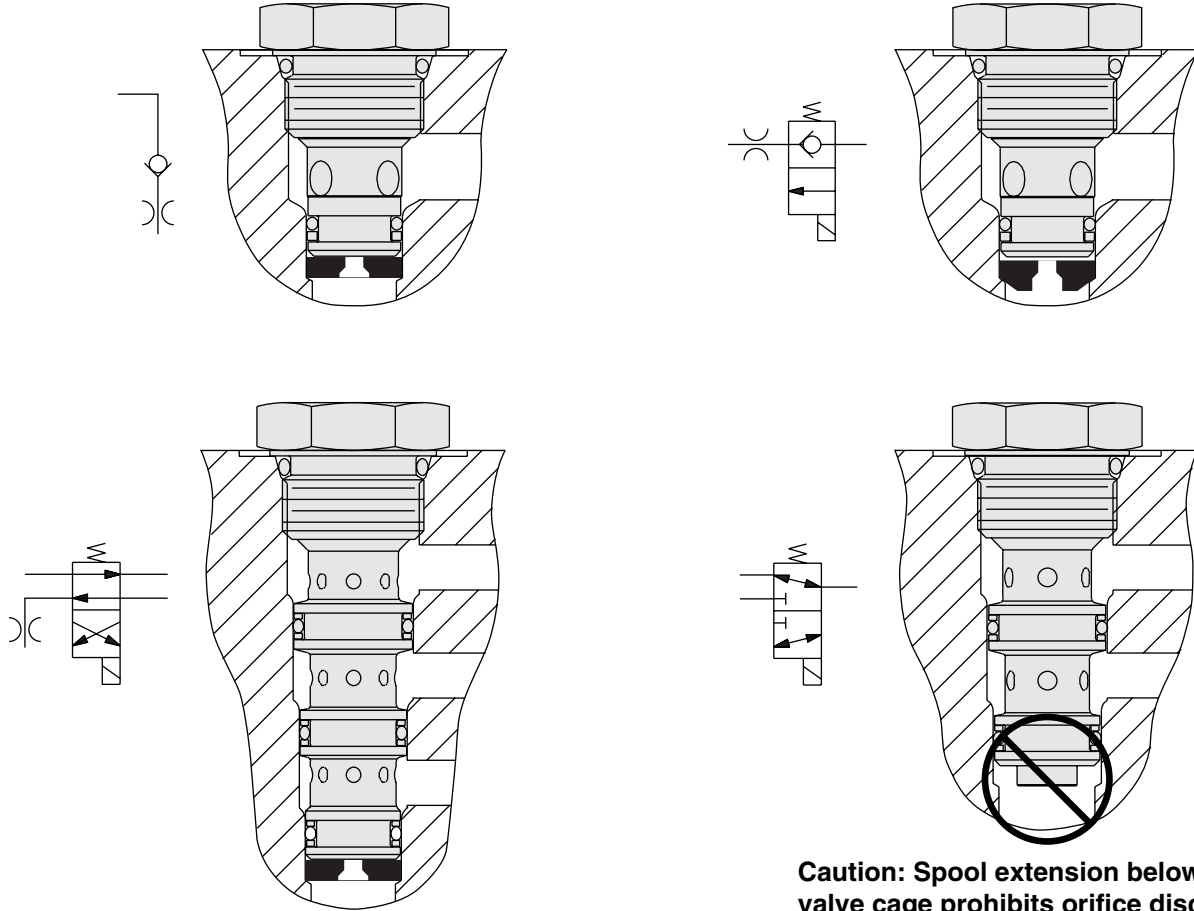

Caution: Spool extension below the valve cage prohibits orifice disc use.

ORDERING INFORMATION

See Orifice Sizing Guide charts on pages 8.460.3 and 8.460.4 for information necessary to specify Drill-Thru Diameter.

	70	
	┌───┐ ┌───┐	
	│ │	
Disc Dia.		Drill-Thru Diameter
.500 in. 51		Specify in thousandths of an inch;
.562 in. 57		For example:
.625 in. 63		000 Blank
.810 in. 81		031 .031 in. Drill-Thru Diameter
.875 in. 88		

HOUSINGS AND ACCESSORY PRODUCTS

Orifice Disc Sizing Guides

ORIFICE DISC SIZING GUIDE (Inches)

Curves represent orifice disc drill-thru diameters.

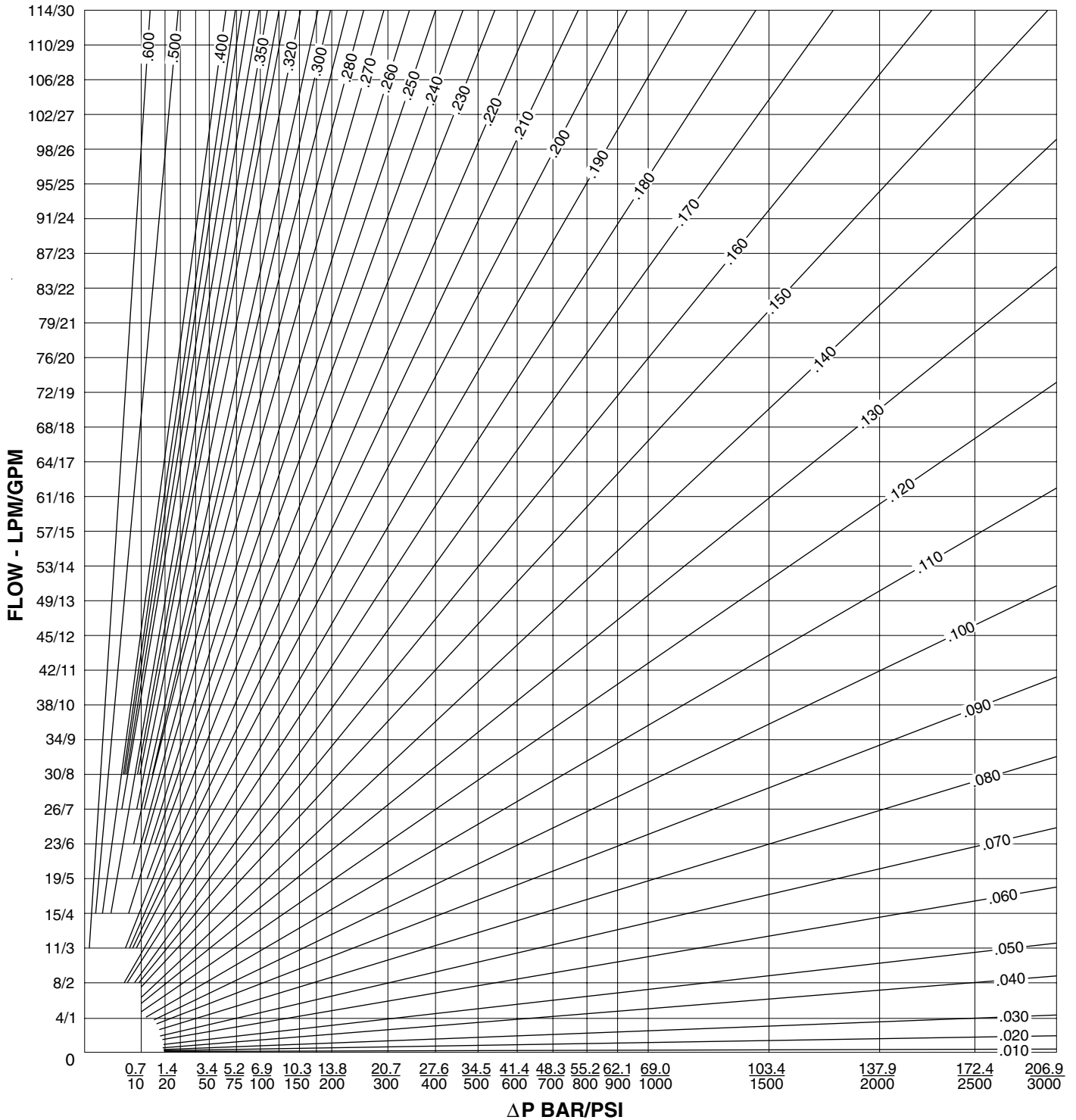

Note: Table is calculated at 32 cSt (150 SSU) oil at 40°C. Values will change with viscosity changes.

Orifice Disc Sizing Guides (cont'd)

ORIFICE DISC SIZING GUIDE (mm)

Curves represent orifice disc drill-thru diameters.

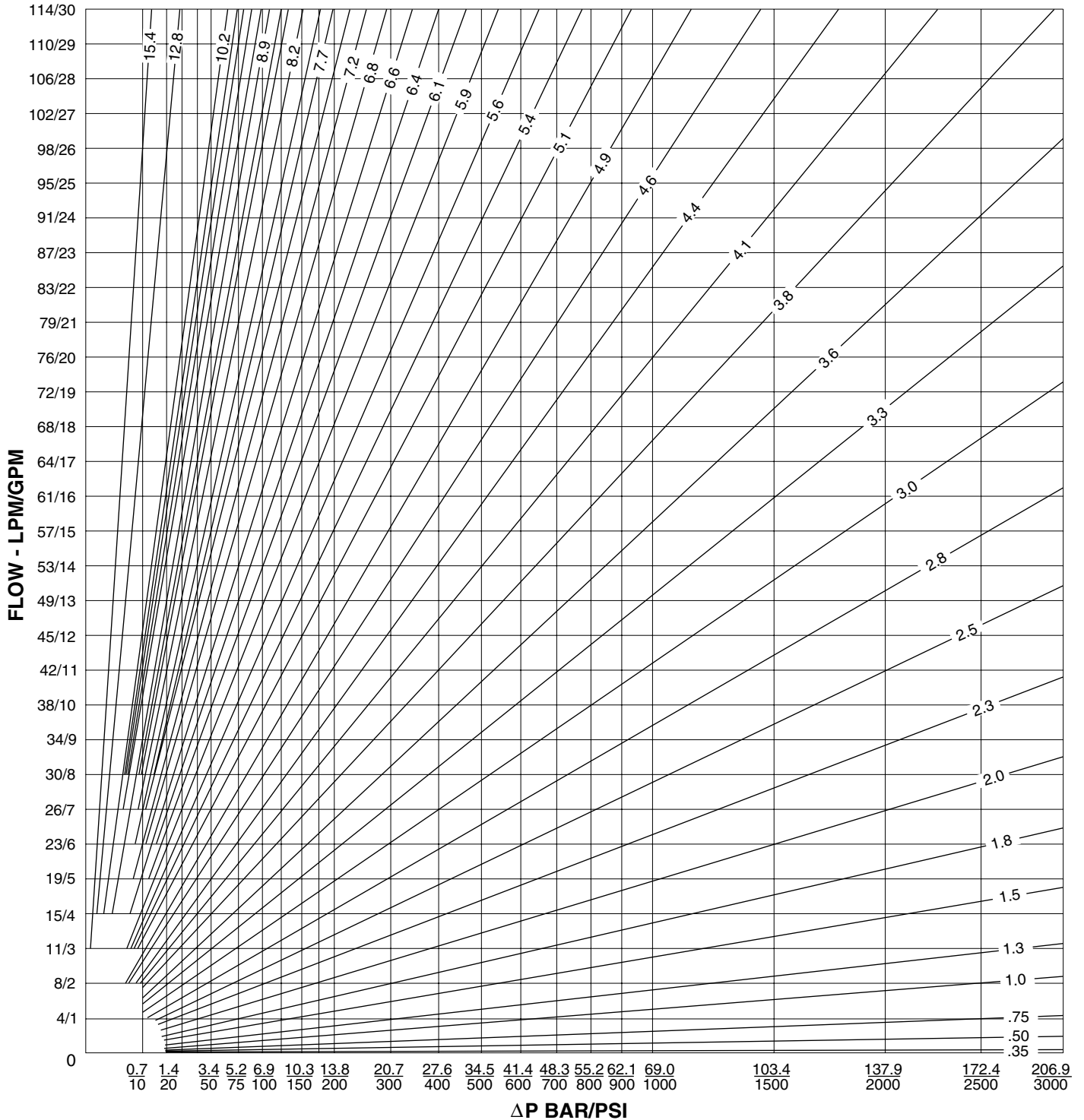

Note: Table is calculated at 32 cSt (150 SSU) oil at 40°C. Values will change with viscosity changes.